

4" METER PIT AND SETTING WITH BY-PASS KCMO

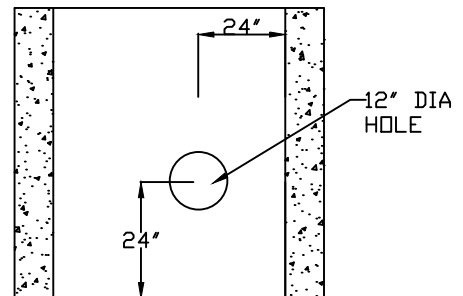
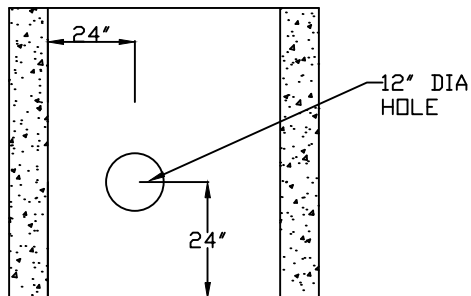
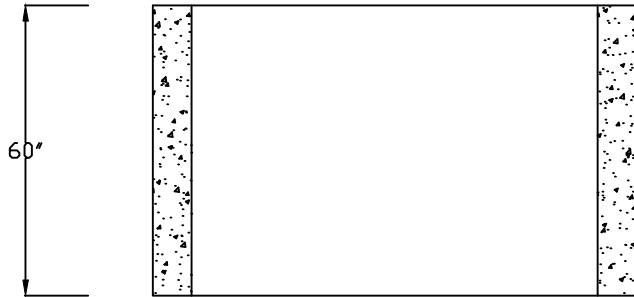
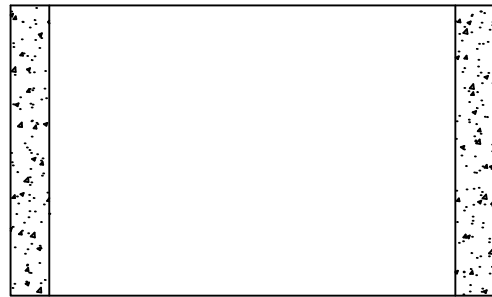
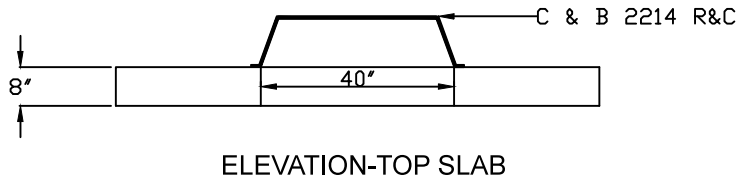
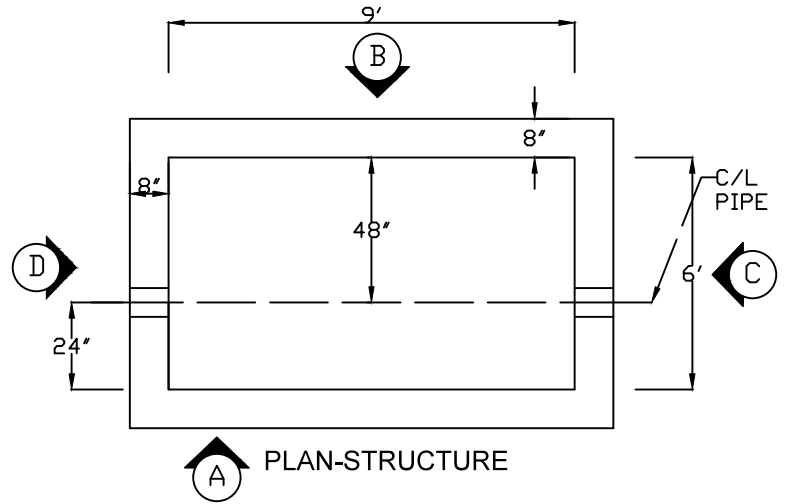
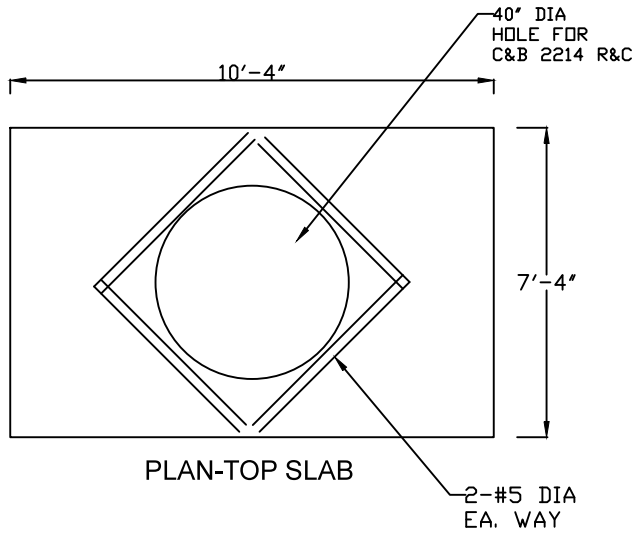

WT. TOP SLAB 7356#
WT. BOT SECT. 15750#

REBAR PLACEMENT
#5 @ 12" C/C EA. WAY WALLS
#5 @ 6" C/C EA. WAY TOP SLAB