

CONTRACTOR

PROJECT
8" FULL FLOW METER VAULT - KCMO.

WT. TOP SLAB (L) 2496#

WT. TOP SECT 10168#

WT. MID SECT #####

WT. BOT SECT 11093#

WT. TOP SLAB (M) 8346#

WT. TOP SLAB (R) 4953#

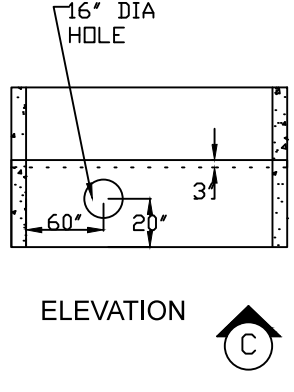
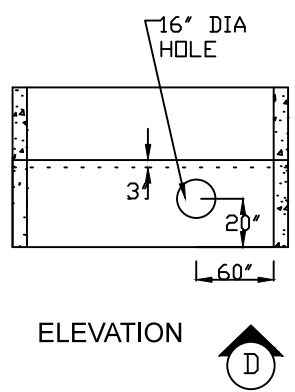
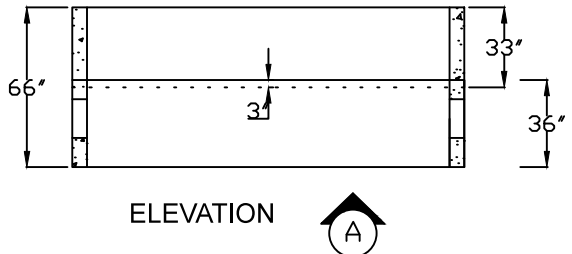
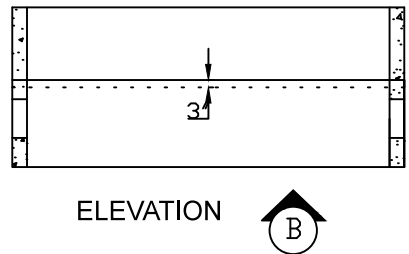
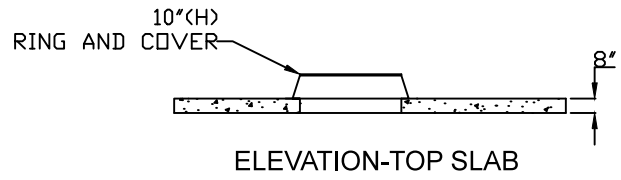
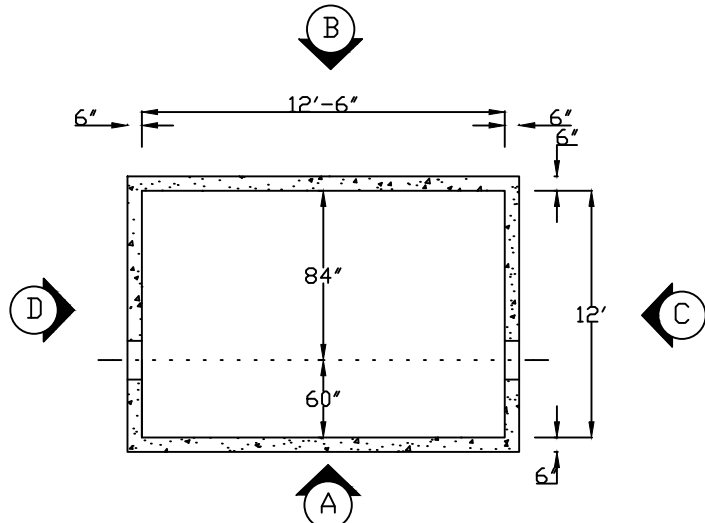
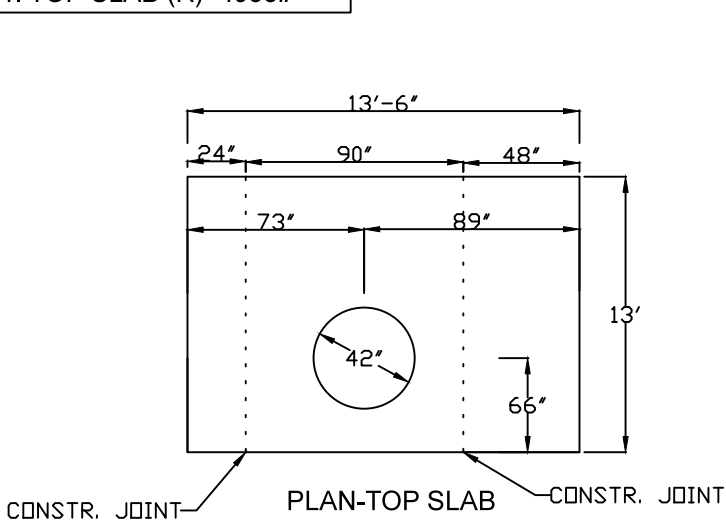

REBAR PLACEMENT

#4 @ 12" C/C EA. WAY WALLS

#5 @ 6" C/C EA. WAY TOP SLAB

#4 @ 6" C/C EA. WAY BOT SLAB

RELIABLE CONCRETE PRODUCTS (913) 321-8108
615 SCOTT* KANSAS CITY, KANSAS 66119

STRUCTURE DESIGNATION
8" FULL FLOW METER VAULT

DATE
08/05/14