

REBAR PLACEMENT

- #4 @ 10" C/C EA. WAY WALLS
- #4 @ 10" C/C EA. WAY TOP SLAB
- #4 @ 10" C/C EA. WAY BOT SLAB

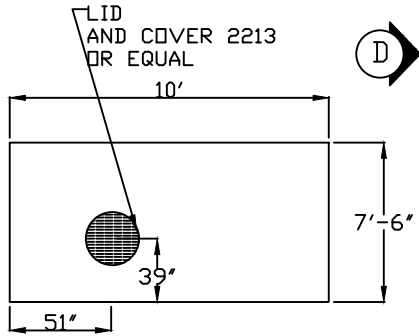

PLAN-TOP SLAB

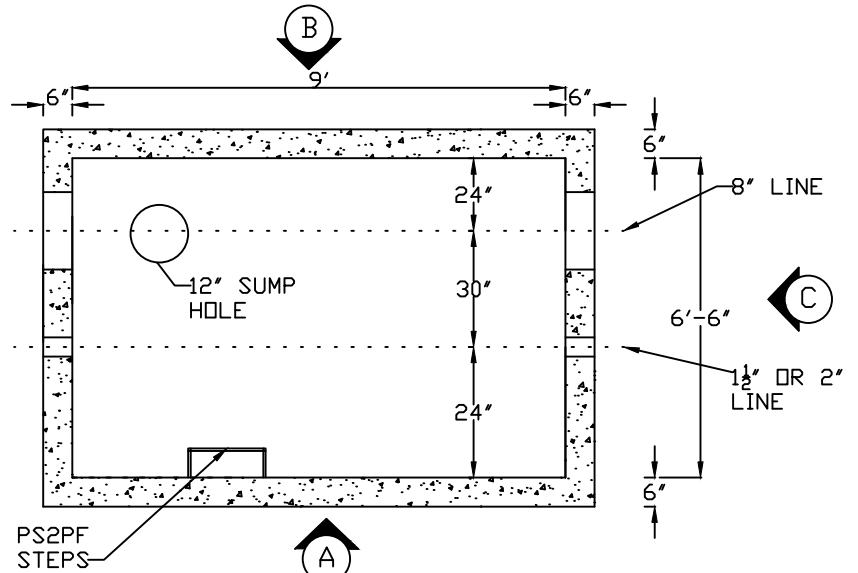

PLAN-STRUCTURE

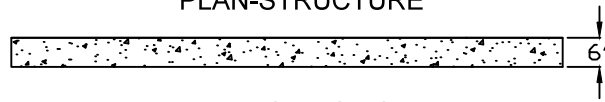

ELEVATION-TOP SLAB

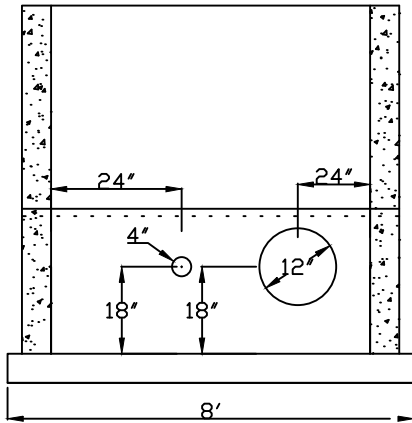

ELEVATION

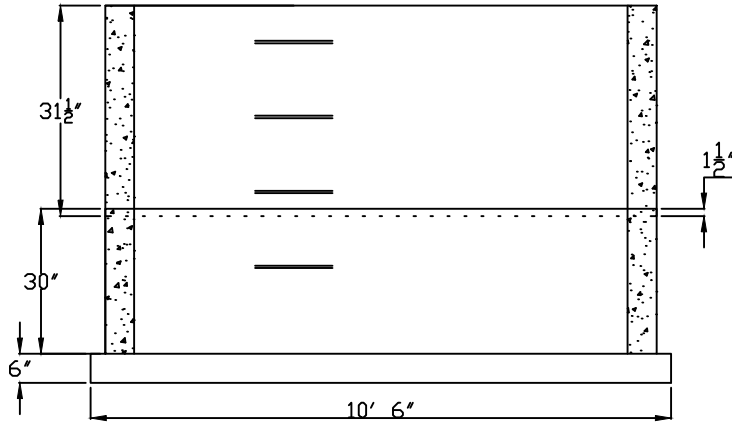

ELEVATION

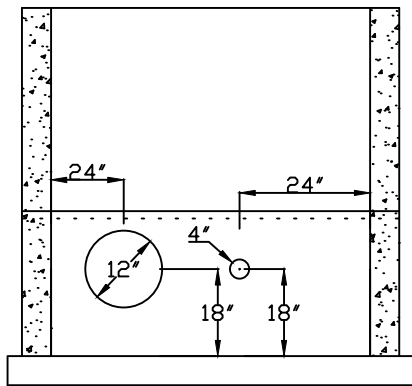

ELEVATION

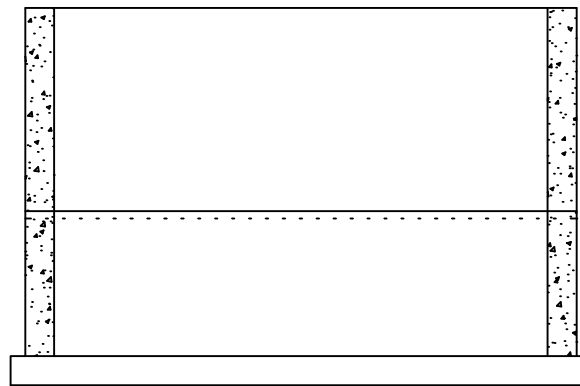

ELEVATION



WT. TOP SLAB 7161#
 WT. TOP SECT 6000#
 WT. BOT SECT W/BASE 14970#