

REBAR PLACEMENT

- #4 @ 10" C/C EA. WAY WALLS
- #4 @ 10" C/C EA. WAY TOP SLAB
- #4 @ 10" C/C EA. WAY BOT SLAB

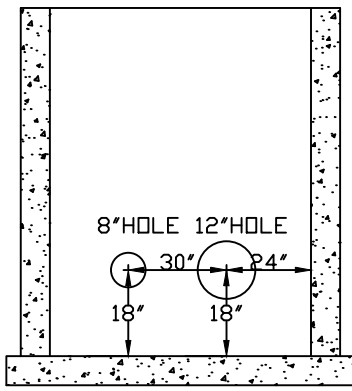

ELEVATION

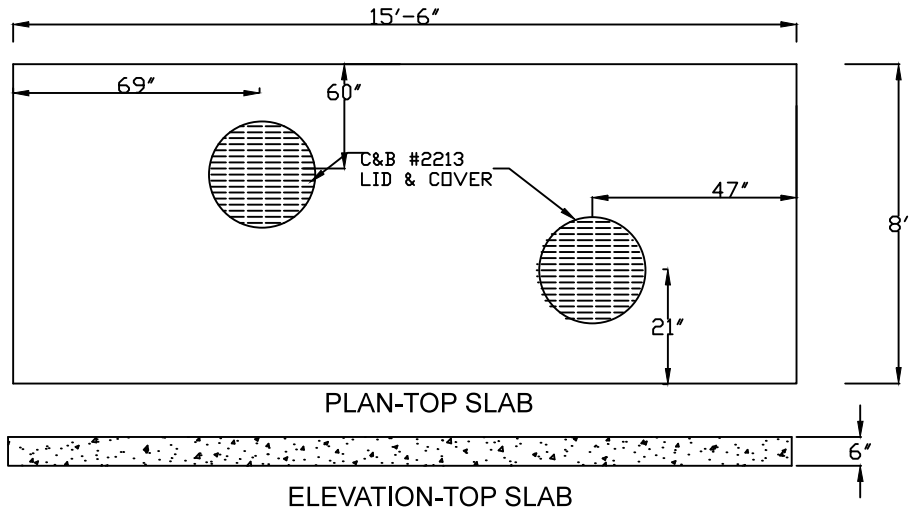
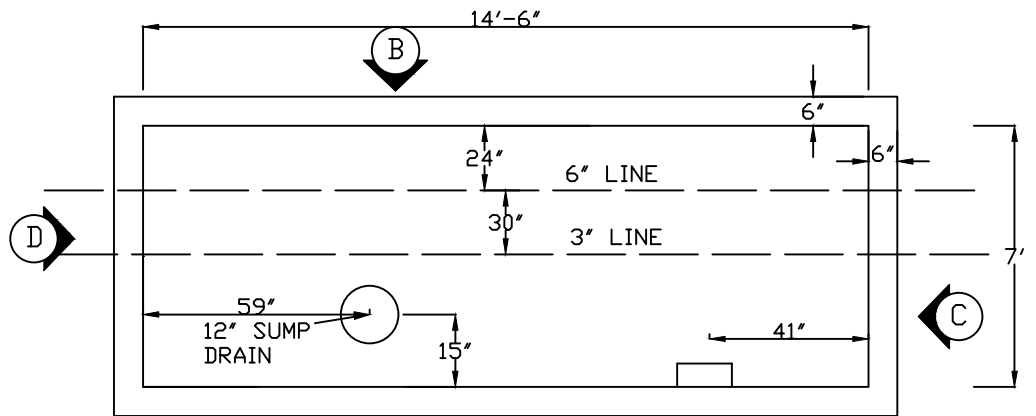

PLAN-STRUCTURE

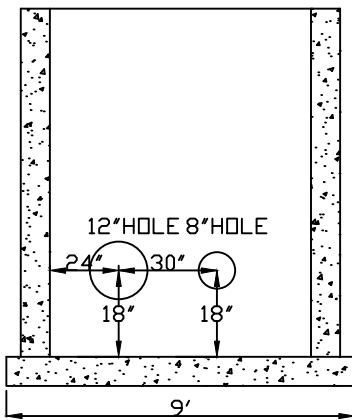

ELEVATION

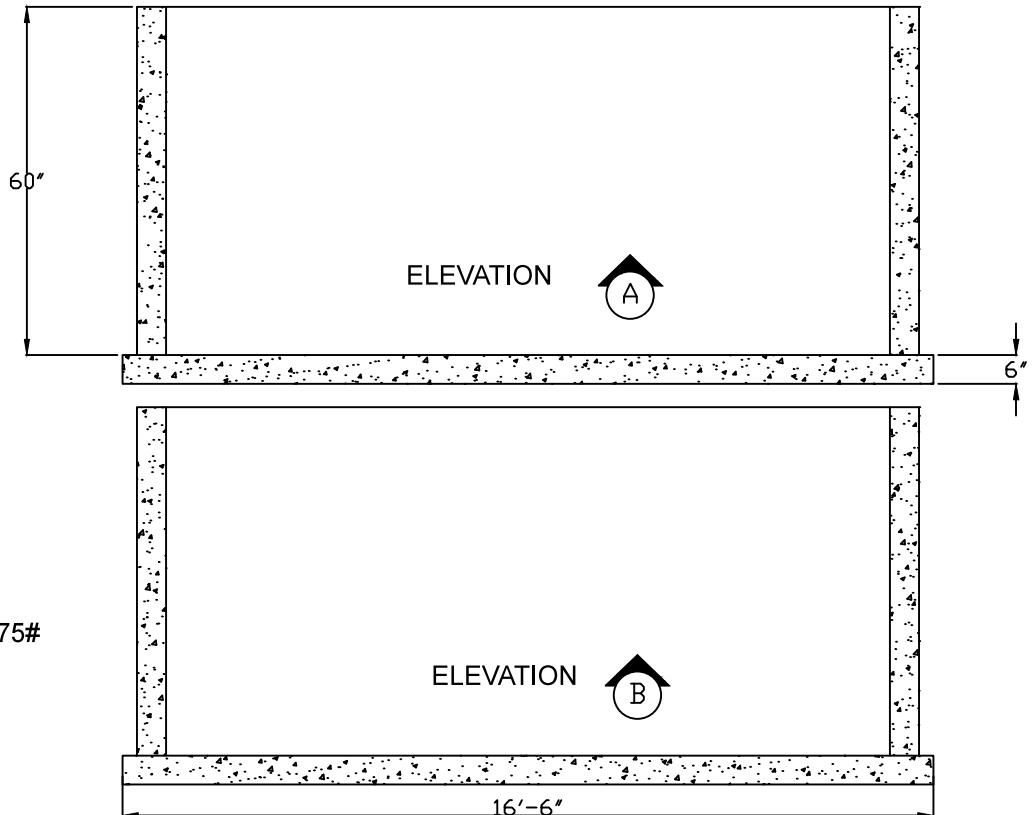

ELEVATION



ELEVATION



WT. TOP SLAB 9300#

WT. BOT. SECT.WBASE 31375#